

SECESPOL HEAT EXCHANGERS TECHNICAL DATA SHEET

LA14 - 30

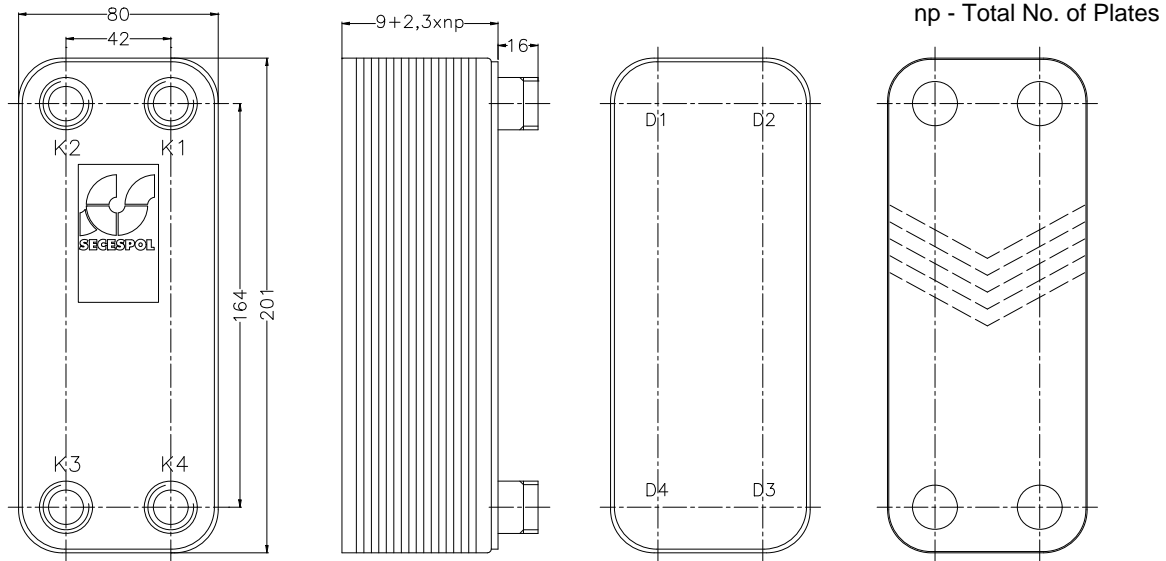

WORKING CONDITIONS:

Max. Pressure	
Copper Brazed	3.0 MPa
Nickel Brazed	1.6 MPa
Max. Temperature	
Copper Brazed	230 deg.C
Nickel Brazed	350 deg.C
Min. Temperature	
Copper Brazed	-195 deg.C
Nickel Brazed	-160 deg.C

STANDARD OF CONNECTIONS LOCATION: (Counter-Flow)

K1 - Inlet Hot Side
K2 - Outlet Cold Side
K3 - Inlet Cold Side
K4 - Outlet Hot Side

DESIGN DATA:

Heat Transfer Area	
Type	Corrugated Plate
Size	0.4 m ²
Hot Side Volume	0.3 l
Cold Side Volume	0.3 l
Weight	2.1 kg
Total No. of Plates	31

WORLDWIDE STANDARDS:

SECESPOL products are manufactured in accordance with ISO 9001:2000 and built to the highest standards and to the world's most demanding codes: PED 97/23/EC

CONNECTION TYPES:

K1, K2, K3, K4:	
G 1/2"	Internal Thread
G 1/2", G 3/4"	External Thread
ID: 18; 22 mm	Sweat

SECESPOL

MATERIALS:

Heat Transfer Area	00H17N14M2 [H17N13M2T, 1H18N9T, 0H18N9]
Thread Connection	00H17N14M2 [H17N13M2T, 1H18N9T, 0H18N9]
Sweat Connection	00H17N14M2 [H17N13M2T, 1H18N9T, 0H18N9]
Soldering Material	Cu99.95B, Ni

SECESPOL Sp. z o.o., ul. Grunwaldzka 339, 80-309 Gdansk Poland
tel.: +48 58 5523287, fax: +48 58 5521412, info@secespol.pl, www.secespol.pl